





**NR 1**

**(B1)**  8x28 x28

**(B2)**  8x50 x20

**(B3)**  6x45 x48

**(M1)**  x56+16

**(T1)**  x48+16

**(W1)**  x32

**(T12)**  L=24/40 x4

**(K1)**  7x50 mm x2

**NR 2**

**(C2)**  x72

**(C1)**  x2

**(S4)**  3,0x20 x13

**(M6)**  x12

**(P16)**  4,2x12 x12

**(F15)**  x6

**NR 3**

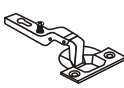
**(Y1)**  Kr15 x8

**(Y5)**  H2 x8

**(S8)**  4x13 x16

**(E3)**  6,3x13 x16

**NR 4**

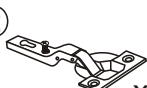
**(Y2)**  Kr8 x8

**(Y5)**  H2 x8

**(S8)**  4x13mm x16

**(E3)**  6,3x13mm x16

**NR 5**

**(U61)**  x2

**(A14)**  M4x23 x4

**NR 6**

**(F7)**  x2

**(S1)**  3,0x13mm x2

**NR 7**

**(J11)**  x2

**(P13)**  3,5x13 mm x4

**NR 8**

**(G7)**  x2



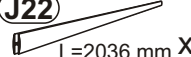

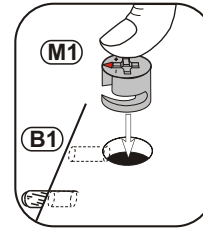
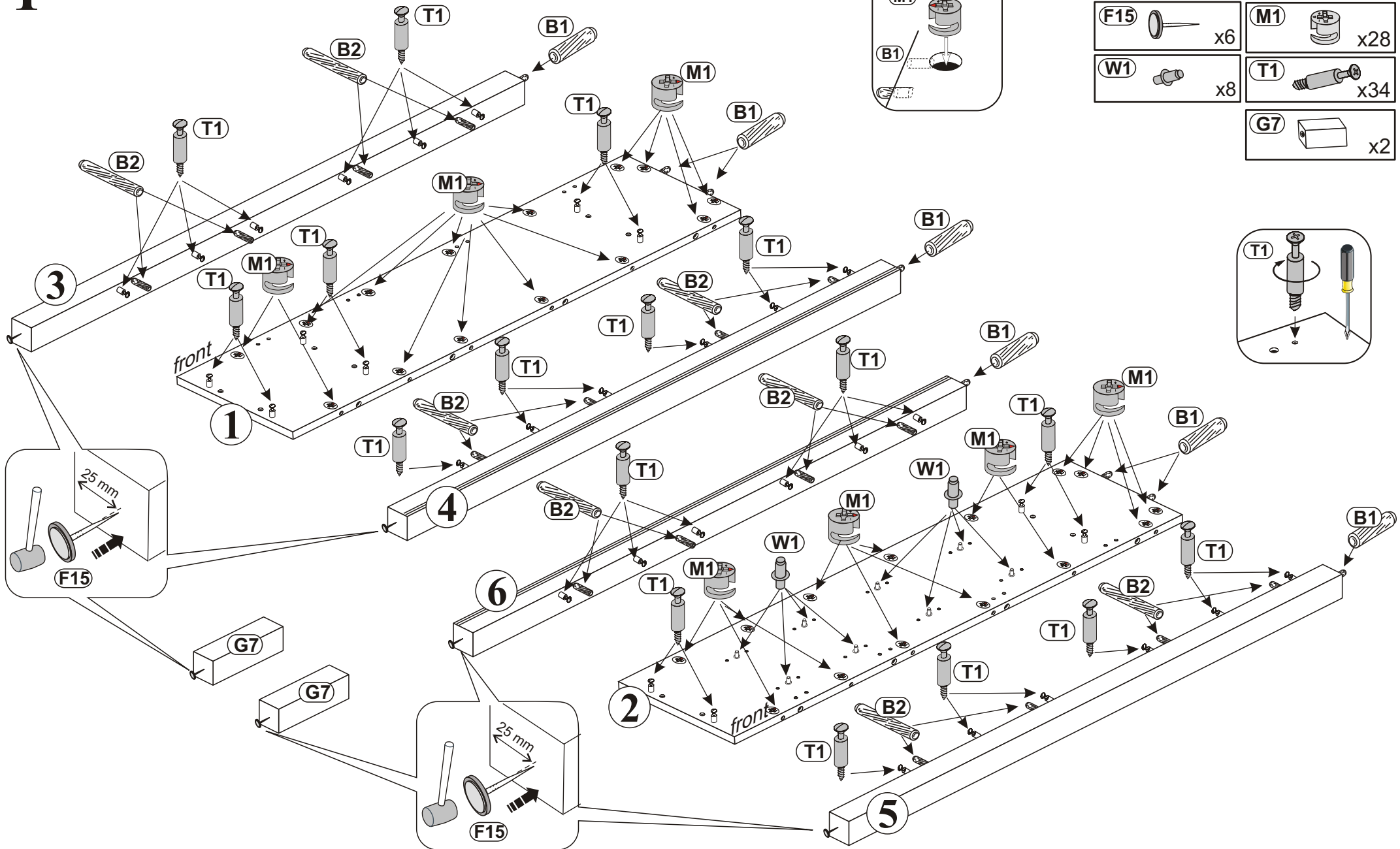

**(J20)**  L=973mm x1

**(J22)**  L=2036 mm x1



1



<b>B2</b>  8x50 x16	<b>B1</b>  8x28 x8
<b>F15</b>  x6	<b>M1</b>  x28
<b>W1</b>  x8	<b>T1</b>  x34
<b>G7</b>  x2	

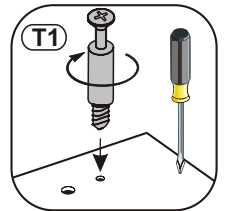

2

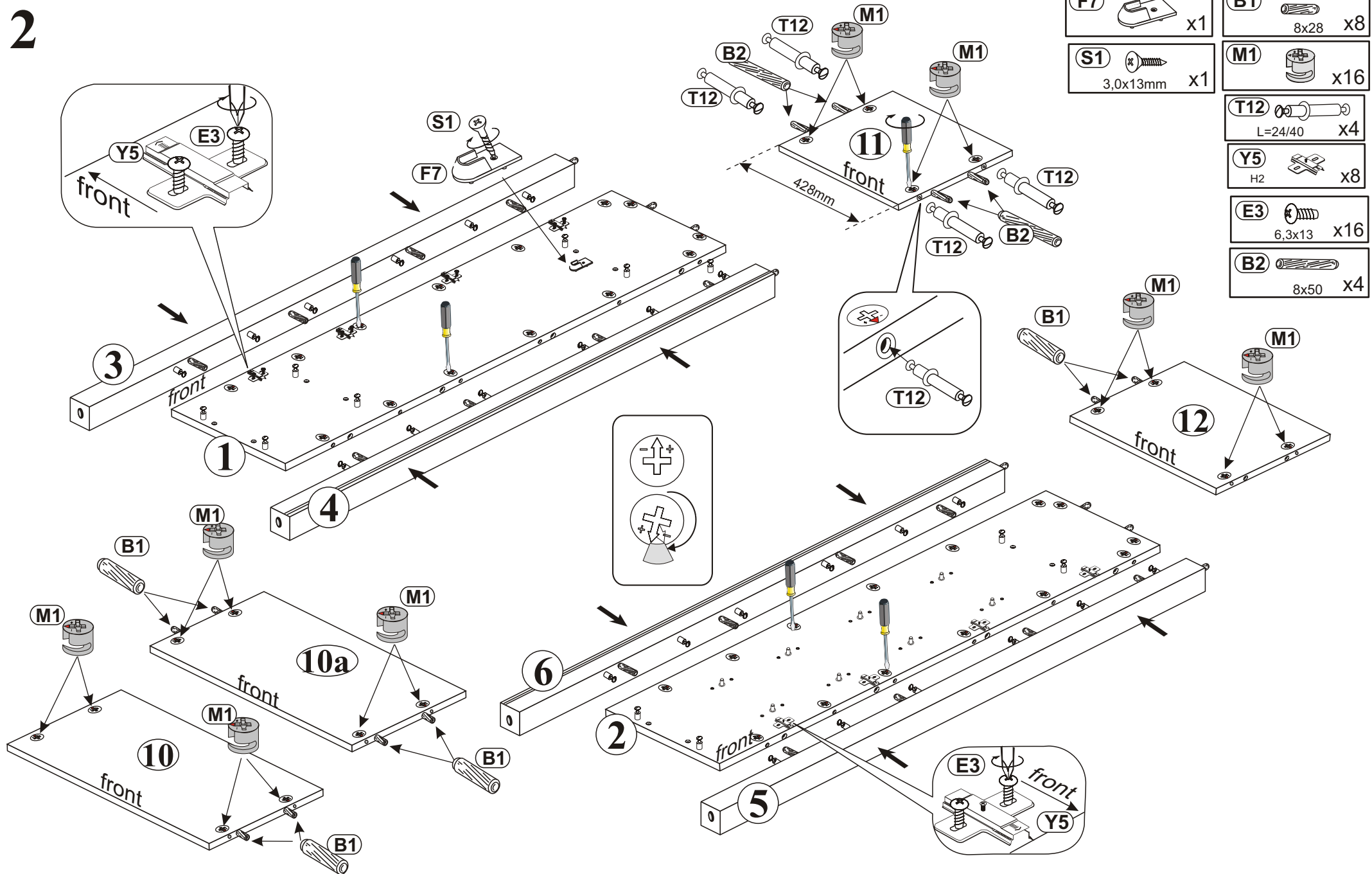

3

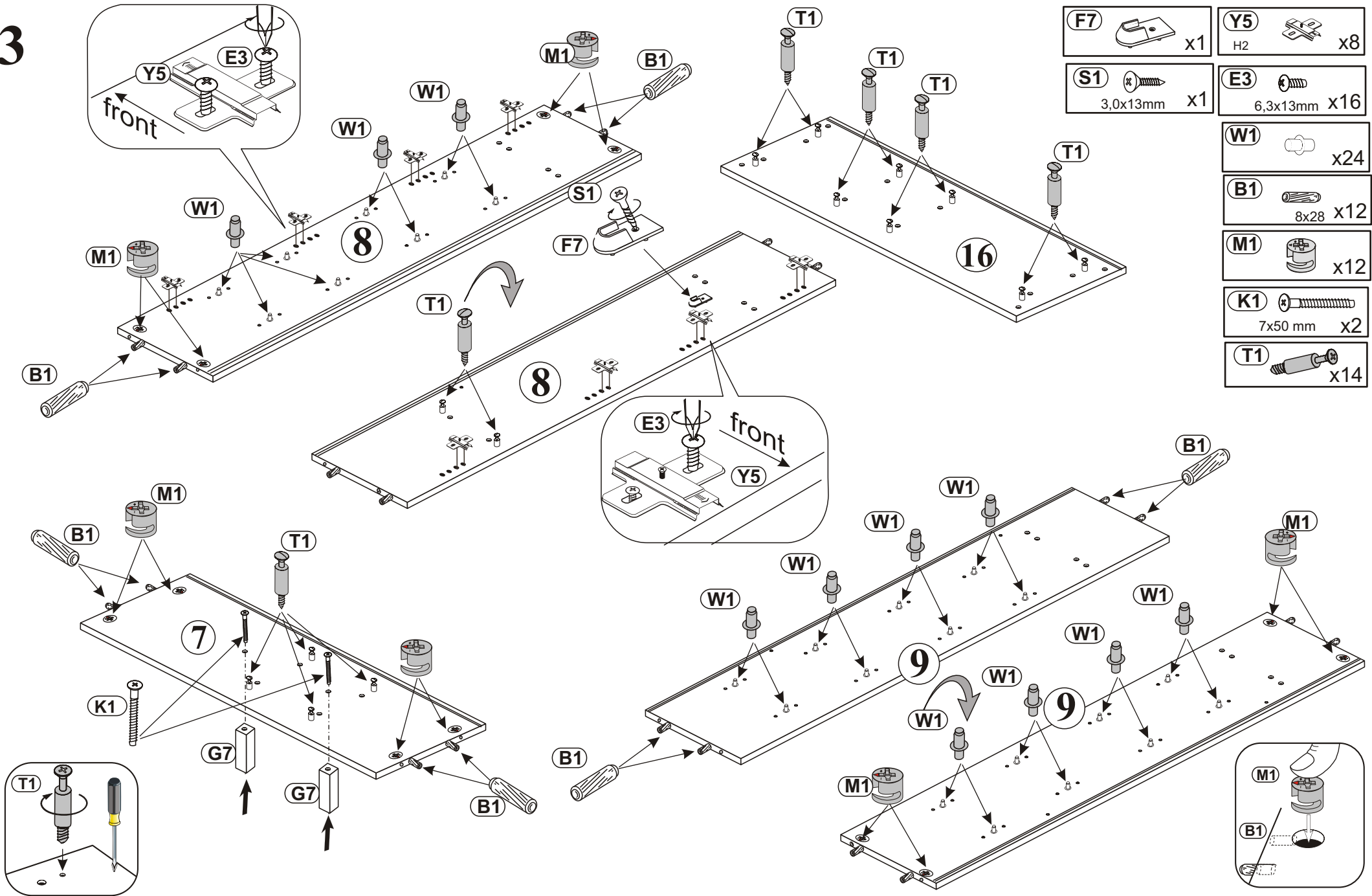

**F7** x1

**Y5** x8  
H2

**S1** x1  
3,0x13mm

**E3** x16  
6,3x13mm

**W1** x24

**B1** x12  
8x28

**M1** x12

**K1** x2  
7x50 mm

**T1** x14

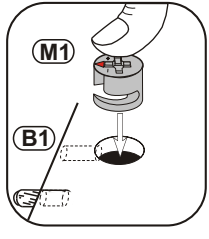
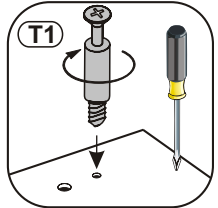

4

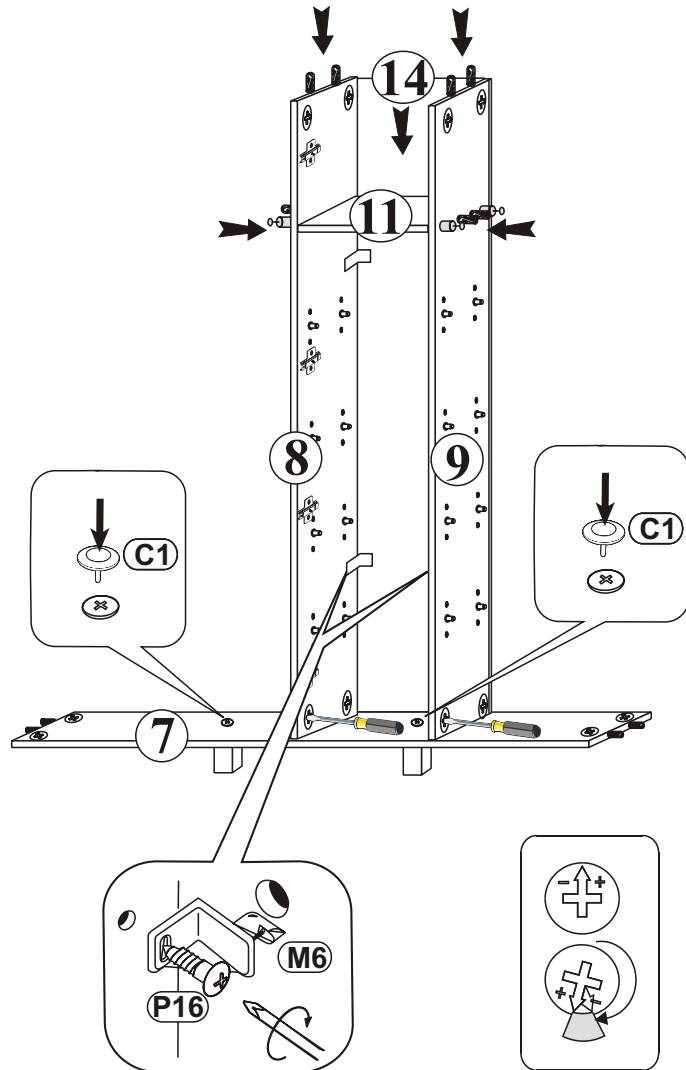
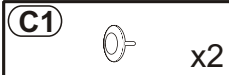

5

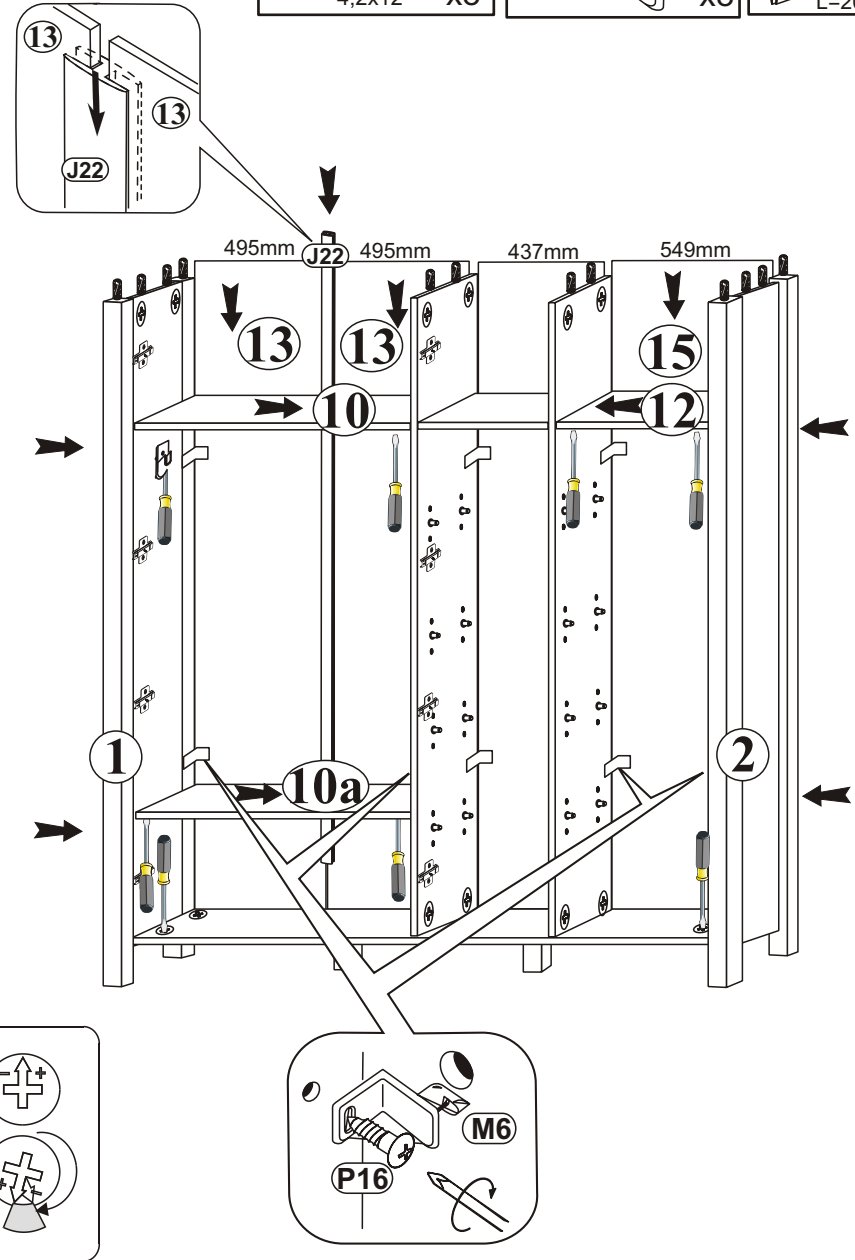
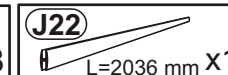
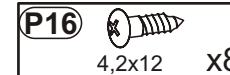

6

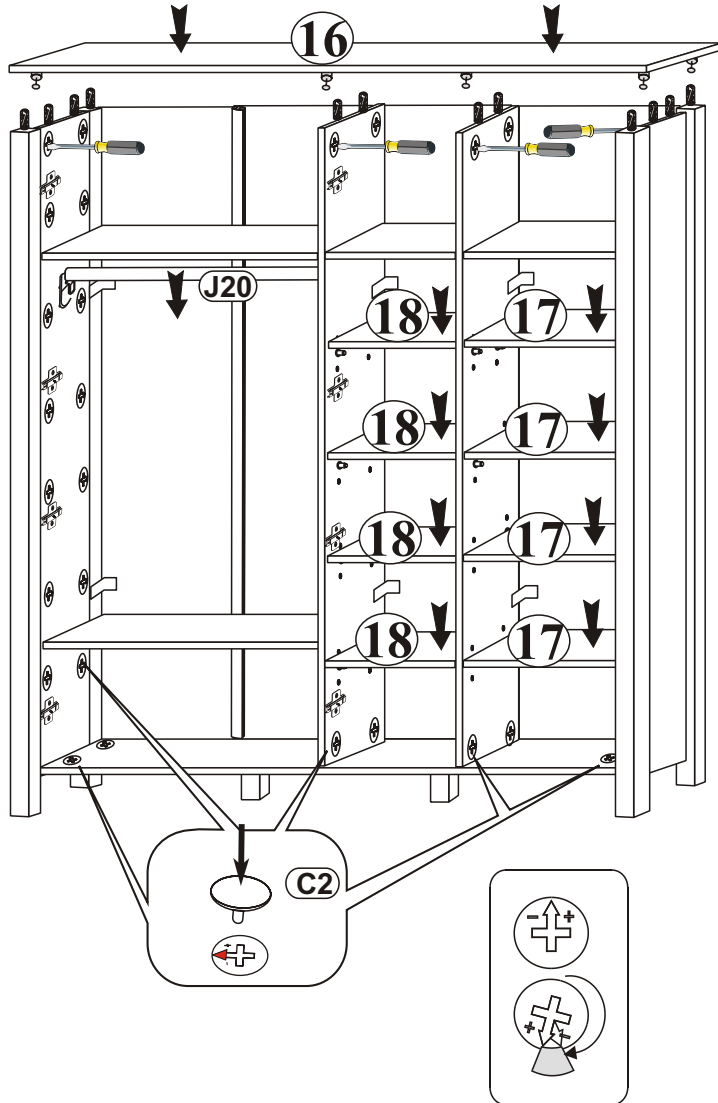
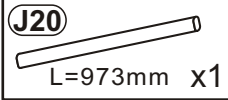



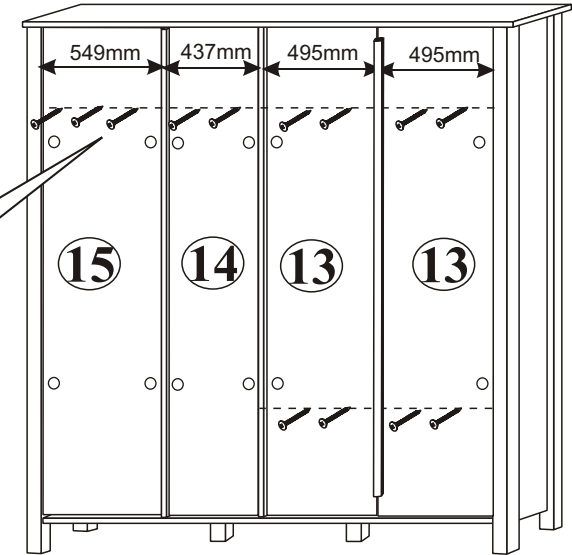
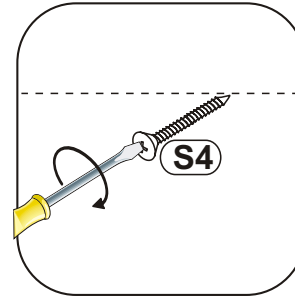
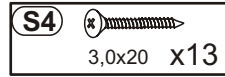

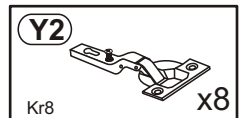
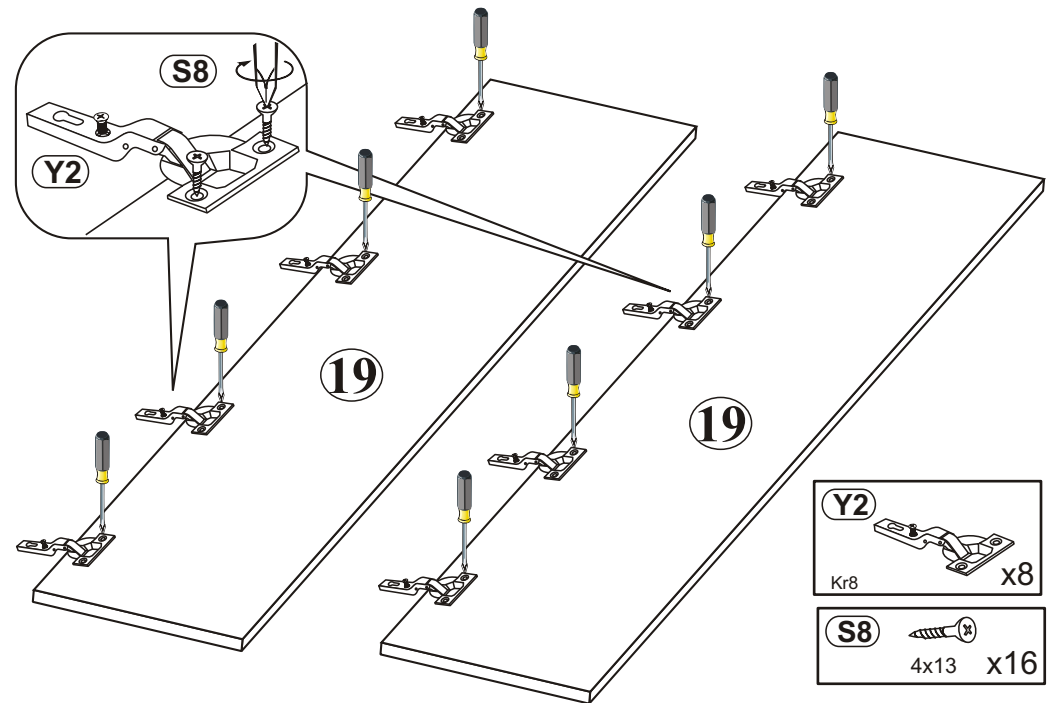
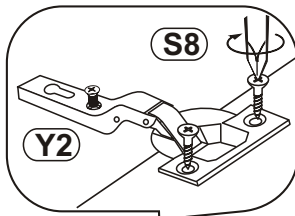

7

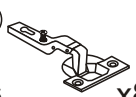

8

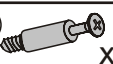

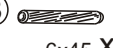
9

- |   |  |  |
|---|--|--|
| <b>M1</b><br> x16      | <b>Y1</b><br> Kr15 x8     | <b>U61</b><br> x2 |
| <b>T1</b><br> x16      | <b>A14</b><br> M4x23 x4   | <b>C2</b><br> x16 |
| <b>B3</b><br> 6x45 X48 | <b>S8</b><br> 4x13 mm x16 |  |

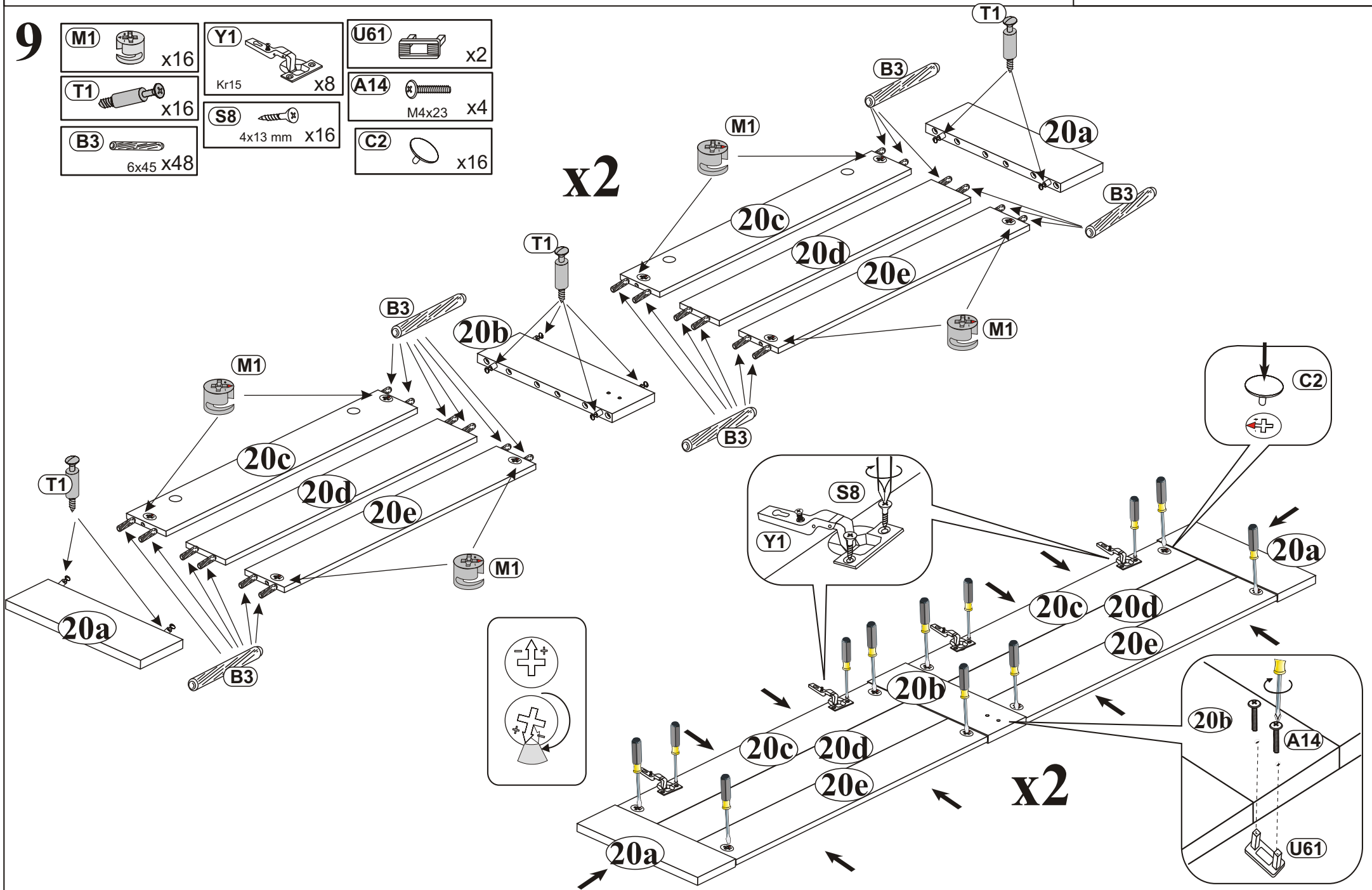



10

